

Groupwork Table Facts

 Specifying, pages 564–573

Groupwork furniture supports team activities. It is appropriate in an open plan and an enclosed work space. Table tops and table legs are ordered separately.

Tables are 28½"H.

90° corner bridge creates additional seating where space is a premium.

Worksurfaces are woodcore with True Performance Laminate surface.

Worksurfaces have 2" radius corners with 3 mm edge band on all sides. Edge band is color matched to laminate.

Table legs ship standard with levelers. Casters are optional.

Groupwork tables are available with T-legs and post legs.

Conference tops come standard with a grommet. For one-piece conference tops, the grommet is centered in the middle of the table. For two-piece conference tops, two grommets are standard, with grommets positioned 21" from the middle to the center of the grommet.

Flip grommets are available for cable routing needs.

Conference tops are offered in four shapes—rectangular, boat-shaped, race-track, and oval. Table tops come in one piece (96"W) or two pieces (120W or 144"W). Oval is offered in 96"W only. All tops are offered in standard 1½" or optional 1¾" thickness. All conference tops come standard with grommet.

Media table has a 24" diameter surface to support technology needs and adjusts from 22"–32"H. Table top turns for convenience.

Grommets are available in packages of 10 to finish exposed edges of field-installed openings in the worksurface for vertical cable routing. Grommets are black plastic.

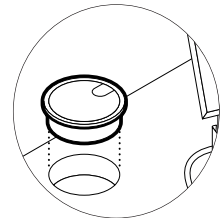

Round and square table tops should be used with either Groupwork round table bases or Groupwork post legs. 48"W oval table top should only be used with Groupwork post legs. All tops are offered in standard 1½" or optional 1¾" thickness.

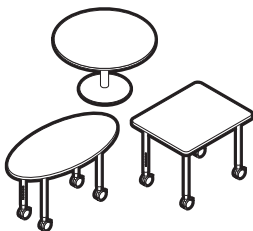
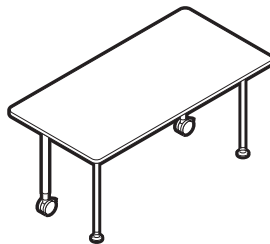
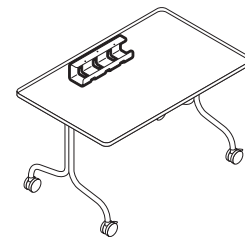

Table legs can be ordered individually to create a combination of two legs with levelers and two legs with casters.



Wire management trough attaches to underside of worksurface to provide cable management and has capacity to support a powerstrip.



Flip grommet is an elegant approach to a basic element. The flip grommet is available field installed only and utilizes a standard 3" hole, which is the same hole size for the TSAEGROM grommet that is standard on Kick, Currency and Groupwork tables.

When cords and wires are routed through the grommet, the flip cover can be closed to hide the routing while providing an upscale design.

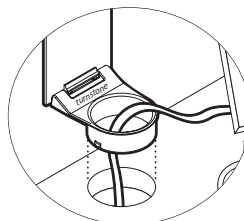

Flip cover is available in two finishes, black and platinum.

The bottom grommet portion is available in black plastic only.

 Specifying, pages 564–573

Personal and personal kidney-shaped tables can be used with square concave tops to create a mobile meeting space for team collaboration.

Personal tables create additional workspace.

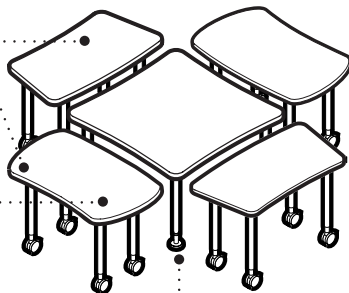

Levelers adjust 2½" from 26½"–29"H for installation on uneven floors.

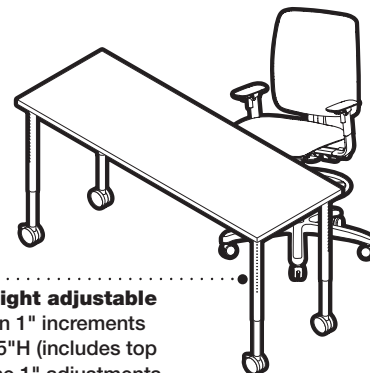

Standing-height adjustable legs adjust on 1" increments from 28½"–45"H (includes top thickness). The 1" adjustments match the Kick Systems vertical upright adjustment pattern.

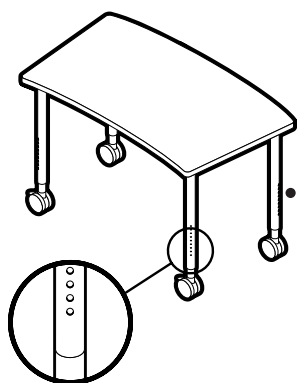

Pin height-adjustable legs are available as an option on post legs and T-legs. Legs adjust at ¼" increments from 26⅝"–32⅝" H (includes top thickness). Pin height-adjustable legs can be used to support nesting applications.

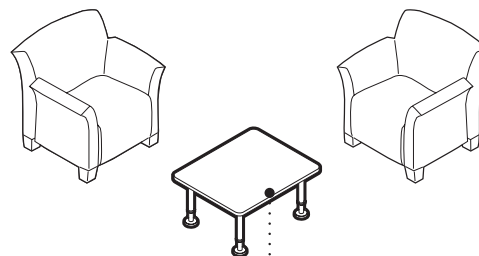
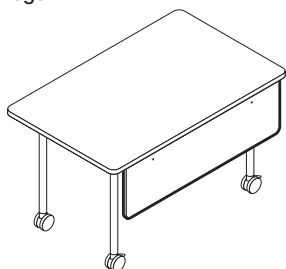

Table tops used with coffee table legs create reception areas or informal team spaces.

Groupwork tables with post legs also blend with Kick Systems furniture. Legs with levelers can adjust up to 29"H only (includes table top).

Modesty panel attaches below rectangular table tops to provide privacy. Modesty panels are 9"H and are ½" thick. Modesty panels are finished with True Performance Laminate on both sides and color matched edges. Modesty panels can be used with any table leg specification, including flip-top legs.



Groupwork tables can be attached together using Kick tie plates (TSATTIE).

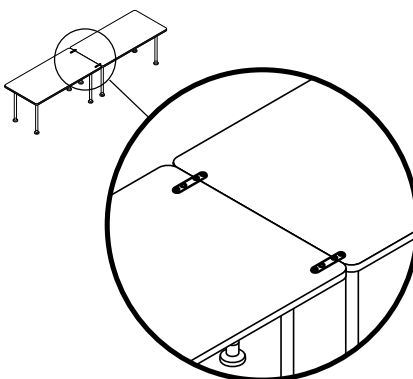

90° corner bridges use Kick in-line support plates for connectivity. 14"D in-line support plates are used with 24"D bridges, and 20"D in-line support plates are used with 30"D bridges.

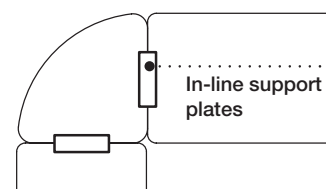

Groupwork Table Configurations

Workstation

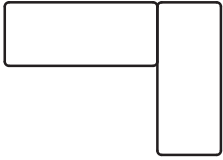

Rectangular tables



Kidney-shaped table

Conference

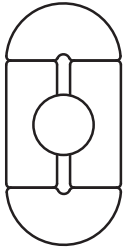

Rectangular, half-round with cutout, and media tables



Rectangular and half-round tables



Rectangular and trapezoid tables

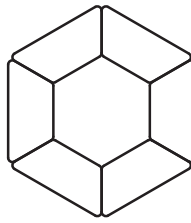

Trapezoid tables

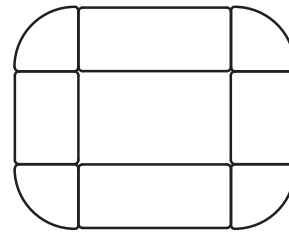

Rectangular tables and 90° corner bridge tables

Team/Collaboration

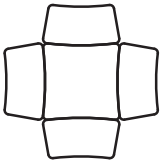

Square concave and personal tables

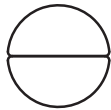

Half-round tables

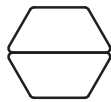

Trapezoid tables

Lecture

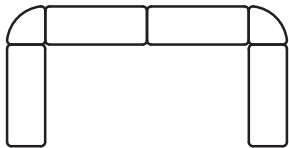

Rectangular tables and 90° corner bridges

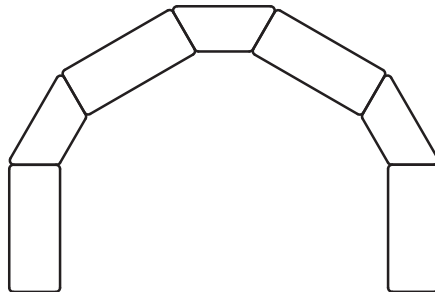

Rectangular and trapezoid tables

Groupwork Table Leg Facts

Legs attach to a top to make it freestanding. Legs support worksurfaces at 28¹/₂"H overall, including worksurface thickness or at standing-height range.

Flip-top legs are available with casters only. Legs come as a pair with all applicable hardware. Legs are used with 24"D and 30"D tops.

Modesty panels can be used with any table leg specification.

Standing-height adjustable leg is available individually or as a package of four legs. Levelers are standard. Casters are available as an option.

T-legs are available as a package of two or as a package of four legs. Levelers are standard. Casters are available as an option. Both versions are available with pin height adjustment.

Leveler with pin height adjustment

Caster with pin height adjustment

Leveler with pin height adjustment

Caster with pin height adjustment

Leveler

Leveler with pin height adjustment

Caster

Coffee table leg is available individually or as a package of four legs. Levelers are standard. Casters are available as an option.

Coffee table legs with levelers, which can adjust 2¹/₂", are used to create coffee-table or end-table heights. For 17" coffee-table height, remove the foam collar from the leveler and reinstall the leveler into the leg. For 19¹/₂" end-table height, leave the foam collar in place. Coffee-table legs with optional casters can also be used to create end-table heights of 19¹/₂" only.

*** Consult the Groupwork table top, leg, and base combinations section of the specification guide for proper leg usage.**
▶ See page 538.



Attachment hardware (screws) is to be used with Currency, Groupwork, or Kick table tops only.

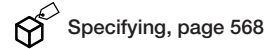
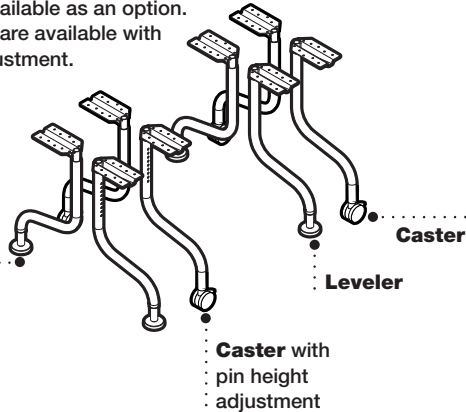

Specifying, page 568

Post leg is available individually or as a package of four legs. Levelers are standard. Casters are available as an option. Both versions are available with pin height adjustment.

Release latch on flip-top legs allows for one-person operation. Top locks in place in the vertical and horizontal positions.

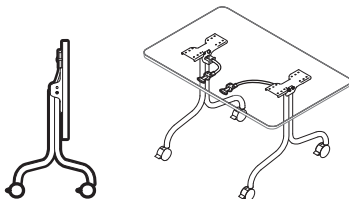

Flip-top tables can be nested for space-saving storage. For 24"D flip-top legs, each nested flip-top table adds approximately 5" to the nesting depth of 23". For 30"D flip-top legs, each nested flip-top table adds approximately 5" to the nesting depth of 30".

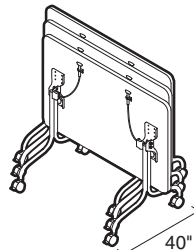

T-legs can be mounted in two positions for 30"D rectangular tops and one position for 24"D rectangular tops.

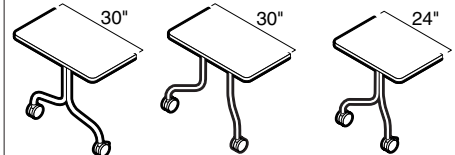

Groupwork Table Base Facts

Bases attach to square, round, or conference table tops. Bases support square and round tops at 28¹/₂"H or 42"H overall, including top thickness. 28"H bases support conference table tops at 28¹/₂"H overall, including top thickness.

 Specifying, page 571

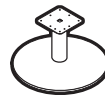
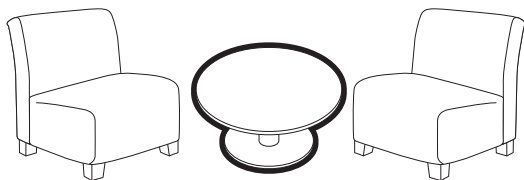
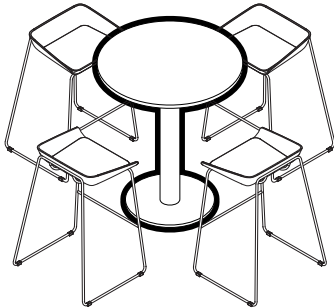

22" diameter by 16¹/₈"H base can be used to create coffee tables with smaller-size round and square tops (24"-30") in reception or teaming areas. Glides are standard.

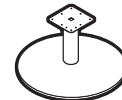

28" diameter by 16¹/₈"H base can be used to create coffee tables with larger-size round and square tops (36" round and square and 42" round) in reception or teaming areas. Glides are standard.

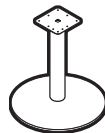

22" diameter by 27³/₈"H base can be used to create standard-height tables with smaller-size round and square tops (24"-30") in cafeterias or teaming areas. Glides are standard.

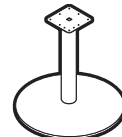

28" diameter by 27³/₈"H base can be used to create standard-height tables with larger-size tops (36" round and square, 42" round, and conference table tops in all sizes) in cafeterias, conference rooms, or teaming areas. Glides are standard.

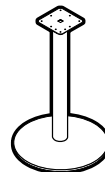

22" diameter by 41"H base can be used to create cafe-height tables with smaller-size round and square tops (24"-30") in cafeterias or general meeting spaces. Glides are standard.

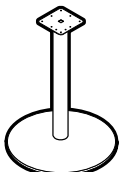

28" diameter by 41"H base can be used to create cafe-height tables with larger-size round and square tops (36") in cafeterias or general meeting spaces. Glides are standard.



Attachment hardware (screws) is to be used with Currency, Groupwork, or Kick table tops only.

Conference table tops can be used with the 28" diameter by 27³/₈"H table base only. Two bases must be used with tops 60"W to 96"W, and three bases must be used with all tops over 96"W.

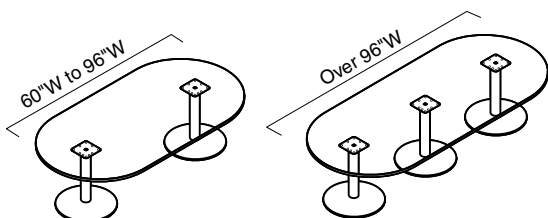

Glides on Groupwork round table bases are not adjustable.

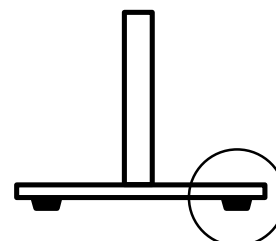

Groupwork Post Leg Clearance Dimensions

18"D Rectangular Tops

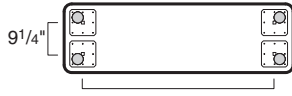

- 48"W = 39 1/4" clearance
- 60"W = 51 1/4" clearance
- 66"W = 57 1/4" clearance
- 72"W = 63 1/4" clearance
- 84"W = 75 1/4" clearance

24"D Rectangular Tops

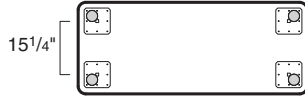

- 36"W = 27 1/4" clearance
- 42"W = 33 1/4" clearance
- 48"W = 39 1/4" clearance
- 60"W = 51 1/4" clearance
- 66"W = 57 1/4" clearance
- 72"W = 63 1/4" clearance
- 84"W = 75 1/4" clearance

30"D Rectangular Tops

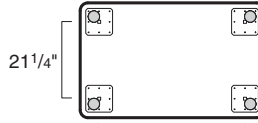

- 36"W = 27 1/4" clearance
- 42"W = 33 1/4" clearance
- 48"W = 39 1/4" clearance
- 60"W = 51 1/4" clearance
- 66"W = 57 1/4" clearance
- 72"W = 63 1/4" clearance

Square Tops

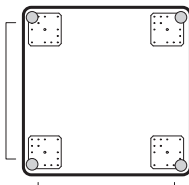

- 36"W = 27 1/4" clearance
- 42"W = 33 1/4" clearance
- 48"W = 39 1/4" clearance

Round Tops

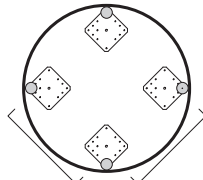

- 36"W = 27 1/4" clearance
- 42"W = 33 1/4" clearance
- 48"W = 39 1/4" clearance

Square Tops—Concave

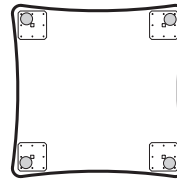

- 36"W = 27 1/2" clearance
- 42"W = 33 1/2" clearance

Half-Round Tops—18" x 36" and 21" x 42"

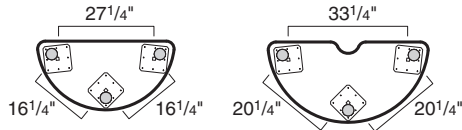

Half-Round Tops—24" x 48" and 27" x 54"

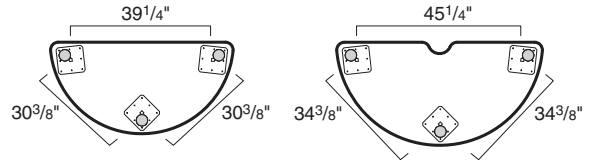

Half-Round Tops—30" x 60" and 33" x 66"

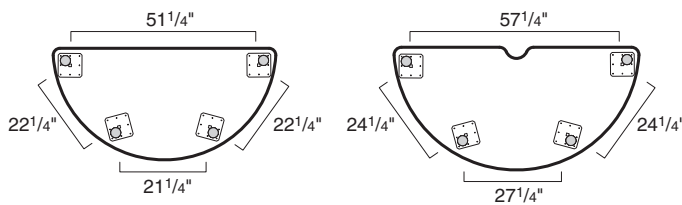

Personal Tops—18" x 36" and 24" x 42"

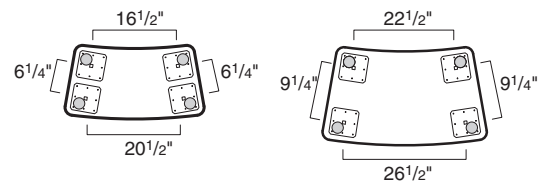

Trapezoid Tops—24" x 48" and 30" x 60"

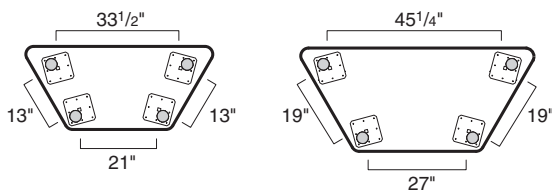



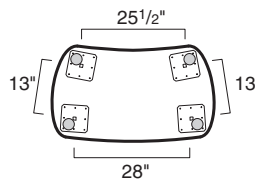





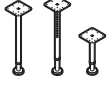





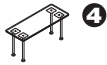
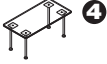





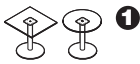
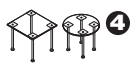

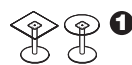













Personal Kidney-Shaped Top



Tables

Groupwork Table Top, Leg, and Base Combinations

	Post Leg, Standing-Height Adjustable Leg, or Coffee Table Leg 	T-Leg 	Flip-Top Legs 	Tie Plates 	In-Line Support Plates 	22" dia. bases  16 ¹ / ₈ "; 27 ³ / ₈ "; and 41" height	28" dia. bases  16 ¹ / ₈ "; 27 ³ / ₈ "; and 41" height
18"D Rectangular Tops ***	 ④	N.A.	N.A.	*	N.A.	N.A.	N.A.
24"D Rectangular Tops	 ④	 ④	 ④	*	N.A.	N.A.	N.A.
30"D Rectangular Tops	 ④	 ④	 ④	*	N.A.	N.A.	N.A.
Round and Square Tops 24" and 30"	N.A.	N.A.	N.A.	N.A.	N.A.	 ①	N.A.
Round and Square Tops 36"	 ④	 ④	N.A.	N.A.	N.A.	N.A.	 ①
Round Tops 42" Diameter	 ④	 ④	N.A.	N.A.	N.A.	N.A.	 ①
Round Tops 48" Diameter	 ④	 ④	N.A.	N.A.	N.A.	N.A.	N.A.
Square Tops 42" and 48"	 ④	 ④	N.A.	N.A.	N.A.	N.A.	N.A.
Oval Top 48"	 ④	N.A.	N.A.	N.A.	N.A.	N.A.	N.A.
Half-Round Tops 18" x 36" and 21" x 42" ***	 ③	N.A.	N.A.	*	N.A.	N.A.	N.A.
Half-Round Tops 24" x 48" and 27" x 54" ***	 ③	 ③	N.A.	*	N.A.	N.A.	N.A.
Half-Round Tops 30" x 60" and 33" x 66"	 ④	 ④	N.A.	*	N.A.	N.A.	N.A.
Trapezoid Tops 24" x 48" ****	 ④	N.A.	N.A.	*	N.A.	N.A.	N.A.
Trapezoid Tops 30" x 60"	 ④	 ④	N.A.	*	N.A.	N.A.	N.A.
Personal Tops 18" x 36" ***	 ④	N.A.	N.A.	*	N.A.	N.A.	N.A.
Personal Kidney-Shaped Tops 24" x 42" ***	 ④	 ④	N.A.	*	N.A.	N.A.	N.A.
Square Tops- Concave	 ④	 ④	N.A.	*	N.A.	N.A.	N.A.

① = Number of legs for table







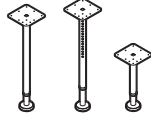

* = Tie plates to be used when ganging tables with levelers to keep table together.

** = In-line support plates to be used on 24"D and 30"D corner bridge tops connecting to other tables with levelers.

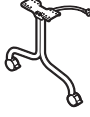
*** = To ensure proper stability, post legs and standing-height adjustable post legs with caster option only cannot be used on these top sizes.

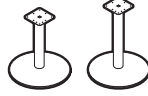
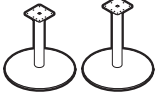
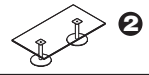
**** = To ensure proper stability, standing-height adjustable post legs with caster option only cannot be used on these top sizes.

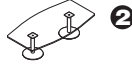
Groupwork Table Top, Leg, and Base Combinations

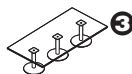
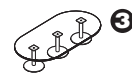
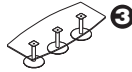
	Post Leg, Standing-Height Adjustable Leg, or Coffee Table Leg	T-Leg	Flip-Top Legs	Tie Plates	In-Line Support Plates	22" dia. bases	28" dia. bases
							
						16 ¹ / ₈ ”, 27 ³ / ₈ ”, and 41” height	16 ¹ / ₈ ”, 27 ³ / ₈ ”, and 41” height
24”D Corner Bridges 90°	N.A.	N.A.	N.A.	N.A.	14”D ** ②	N.A.	N.A.
30”D Corner Bridges 90°	N.A.	N.A.	N.A.	N.A.	20”D ** ②	N.A.	N.A.
Rectangular Conference Tops—48”D x 96”W	N.A.	N.A.	N.A.	N.A.	N.A.	N.A.	 ②
Racetrack Conference Tops—48”D x 96”W	N.A.	N.A.	N.A.	N.A.	N.A.	N.A.	 ②
Boat-Shaped Conference Tops—48”D x 96”W	N.A.	N.A.	N.A.	N.A.	N.A.	N.A.	 ②
Oval Conference Top—48”D x 96”W	N.A.	N.A.	N.A.	N.A.	N.A.	N.A.	 ②
Rectangular Conference Tops—48”D x 120”W and 48”D x 144”W	N.A.	N.A.	N.A.	N.A.	N.A.	N.A.	 ③ 27 ³ / ₈ ” height only
Racetrack Conference Tops—48”D x 120”W and 48”D x 144”W	N.A.	N.A.	N.A.	N.A.	N.A.	N.A.	 ③ 27 ³ / ₈ ” height only
Boat-Shaped Conference Tops—48”D x 120”W and 48”D x 144”W	N.A.	N.A.	N.A.	N.A.	N.A.	N.A.	 ③ 27 ³ / ₈ ” height only

Note: Attachment hardware (screws) is to be used with Currency, Groupwork, or Kick table tops only.

① = Number of legs for table

* = Tie plates to be used when ganging tables with levelers to keep table together.

** = In-line support plates to be used on 24”D and 30”D corner bridge tops connecting to other tables with levelers.

*** = To ensure proper stability, post legs and standing-height adjustable post legs with caster option only cannot be used on these top sizes.

**** = To ensure proper stability, standing-height adjustable post legs with caster option only cannot be used on these top sizes.